



DOUBLE AND COLLECTIVE GARAGE DOORS

Non-protruding up-and-over door ET 500, sliding door ST 500,
up-and-over door N 500

HÖRMANN





4

Good reasons to try
Hörmann doors.



14

Inspirations.



18

Design.
Equipment.
Accessories.

Brand quality made in Germany



The family-owned company Hörmann offers all important construction components for building and renovating projects from a single source. We manufacture in highly specialised factories using state-of-the-art production technologies. Our employees work intensively on new products, continual further developments and improvements to details. The results are patents and unique products on the market.





AN EYE ON THE FUTURE. Hörmann is setting a good example. That's why 100% of our electricity needs in Germany come from green electricity. Together with an intelligent and certified energy management system, CO2-neutral mailing and the recycling of valuable materials, more than 40000 tons of CO2 are saved each year. In addition, we offset over 100000 tonnes of CO2 by promoting wind energy and reforestation projects in cooperation with ClimatePartner.



You can find further information at
www.hoermann.de/umwelt



Sustainable planning for trend-setting construction

Experienced specialists within our customer-oriented sales organisation accompany you from the planning stage, through technical clarification up to the final building inspection. Complete working documentation, such as, e.g. technical manuals, are always accessible and up-to-date at www.hormann.co.uk.





SUSTAINABILITY DOCUMENTED. Hörmann has already received confirmation of sustainability through an Environmental Product Declaration (EPD) in accordance with ISO 14025 from the Institut für Fenstertechnik (ift – Institute of window technology) in Rosenheim, Germany. This EPD was created based on EN ISO 14025:2011 and EN 15804:2012. In addition, the general guidelines for the preparation of type III Environmental Product Declaration apply. The declaration is based on the PCR document “Doors” PCR-TT-1.1:2011.



ARCHITECTS' PROGRAM. Clearly structured navigation via drop-down menus and symbols, as well as a search function, provide faster access to texts for invitations to tenders and more than 9000 drawings (in DWG and PDF format) of over 850 Hörmann products. In addition, BIM data can be provided for many products for the Building Information Modelling process, enabling efficient planning, drafting, construction and management of buildings. Photos and photo-realistic presentations provide additional information on many products.



Plan with the Architects' Program at www.hormann.co.uk/architects-service



**PRODUCTS
FOR BIM**

We are a member of the professional association for digital building products in the Federal Association of Building Systems e.V.

Smooth, quiet door travel even at high frequencies

Twin rollers in the guide rail and guide rollers with ball-bearings allow the door to operate smoothly, quietly and precisely – even in continuous use. The non-protruding up-and-over door ET 500 and the sliding door ST 500 are designed for a service life of at least 250000 door cycles; the up-and-over door N 500 with an optional reinforced spring assembly for approximately 150000 door cycles.





APPROVED DOOR AND OPERATOR UNIT.

All double and collective garage doors are always tested and certified by independent, recognised institutes together with their corresponding operators. This ensures that the door and operator unit run smoothly and securely, which is especially important when fitting the door in public areas, such as underground and collective garages. This is especially important when fitting the door in public areas, such as underground and collective garages.

ALL-ROUND WELL SECURED. The open design with safety clearance between the door leaf and building structure offers reliable protection against finger injuries on the side and bottom edges. A special EPDM profile shape protects the closing edge of the door leaf. For non-protruding up-and-over door ET 500 and sliding door ST 500 an integrated photocell also secures the door opening.

PRACTICAL WICKET DOORS AND SIDE DOORS. On request, double and collective garage doors are also available with a practical wicket door or with a side door matching the design. Wicket doors can be arranged left, right or centre. An overhead door closer is part of the standard scope of delivery.



Innovative operator technology

Hörmann operators offer more convenience, smart functions and intelligent technology. The standard automatic safety cut-out or closing edge safety device stops the door securely and reliably when it encounters an obstacle. Your door opens and closes quietly and smoothly with the soft start and soft stop.





**Soft start /
soft stop**



**Opening speed
up to 0.5 m/s**

QUICK DOOR OPENING. The operator SupraMatic is available in three versions depending on requirements and features an opening speed of up to 0.2 m/s and smart additional functions. With the operator ITO 500 FU, developed specifically for collective garages, you can open the non-protruding up-and-over doors ET 500 and sliding doors ST 500 particularly quickly with an opening speed of up to 0.5 m/s.

→ For further information, see from page 34.



**Easy to fit
and service**



Hörmann BlueControl app
For operator ITO 500 FU and control 560



Online portal SmartControl
For operator ITO 500 FU and control 560

SERVICE-FRIENDLY. Initial start-up, service and maintenance of doors with operator ITO 500 FU is easy and convenient with the new BlueControl app. In addition, the doors can also be integrated into digital service and remote maintenance concepts. Important door information, such as error messages or door cycles, can be accessed via the SmartControl online portal. Users are automatically notified when preconfigured events occur. Remote maintenance can save or shorten on-site service visits and avoid downtime through preventive replacement of wear parts.

→ Available for non-protruding up-and-over doors ET 500 and sliding doors ST 500 with operator ITO 500 FU and control unit 560.

The Hörmann BlueControl app enables smart set-up and adjustment of the operator control.



The SmartControl online portal provides you with the all-round carefree package for permanently reliable door functions.



Intelligent operating comfort

Hörmann offers you a comprehensive range of accessories from hand transmitters and control elements to posts and warning light systems. This allows you to control your door operators easily, safely and conveniently. All operators, receivers and control elements with BiSecur radio technology are 100 % compatible with each other.





Only from Hörmann

CERTIFIED SECURITY. The bidirectional BiSecur radio system with particularly secure encryption protocol and stable, interference-free range makes sure that no one can copy your radio signal. This is also confirmed by the security experts of Bochum University and independent test institutes.



Watch the video on YouTube or at
<https://youtu.be/7QF2i0FhIO8>

→ For further information, see from page 36.

SPECIFICALLY FOR COLLECTIVE GARAGES. With the optional collective garage receiver and the easy-to-use software, you can conveniently and clearly manage up to 1000 hand transmitters. Using the respective hand transmitter programming device, the 868 MHz fixed codes* of the hand transmitters can be read in and assigned to individual flats, and the radio codes transferred to the collective garage receiver via a memory card.

* No BiSecur radio



NON-PROTRUDING UP-AND-OVER DOOR ET 500. When opening and closing, the non-protruding up-and-over door ET 500 swings out only to 30 mm and is therefore optimal for collective garages opening onto pavements, for example.

→ For further information, see from page 28.



SLIDING DOOR ST 500. The design of the sliding door ST 500 features a low fitting depth in the lintel area.

→ For further information, see from page 30.

TOP LEFT. Non-protruding up-and-over door ET 500,
style 413 Anthracite grey RAL 7016

BOTTOM RIGHT. Sliding door ST 500,
style 412 Anthracite grey RAL 7016





TOP LEFT. Up-and-over door N 500, style 402 Window grey RAL 7040

BOTTOM RIGHT. Up-and-over door N 500, style 405, with on-site cladding, installed flush-fitting

UP-AND-OVER DOOR N 500. The swinging up-and-over door N 500 is suited for double garages in private areas and for collective garages with up to 50 parking spaces.

→ For further information, see from page 26.



INDIVIDUAL DESIGNS. All door types offer a wide variety of styles, preferred colours as well as on-site design options.

→ For further information, see from page 20.





20



24

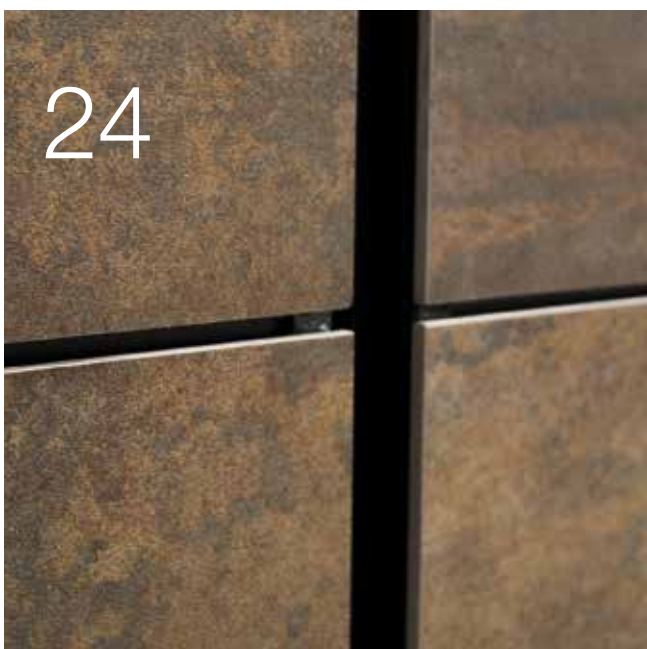

34



Design. Equipment. Accessories.

- 20 Overview
- 22 Door leaf versions
- 24 Colours
- 26 Up-and-over door N 500
- 28 Non-protruding up-and-over door ET 500
- 30 Sliding door ST 500
- 32 Side doors and wicket doors
- 34 Operators
- 36 Accessories
- 38 Dimensions and technical manual

Steel doors

Overview

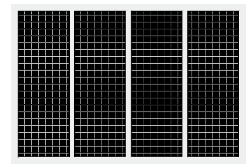
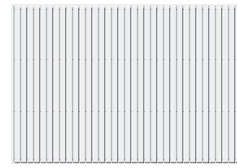

Style	400	402	403
Up-and-over door N 500			
Colour	Traffic white RAL 9016 7 preferred colours RAL to choose	Traffic white RAL 9016 7 preferred colours RAL to choose	Traffic white RAL 9016 7 preferred colours RAL to choose
Max. width (mm)	5000	5000	5000
Max. height (mm)	2750	2750	2750
Non-protruding up-and-over door ET 500 / sliding door ST 500			
Colour	White aluminium RAL 9006 16 preferred colours RAL to choose	White aluminium RAL 9006 16 preferred colours RAL to choose	
Max. width (mm)	6000	6000	
Max. height (mm)	3000	3000	

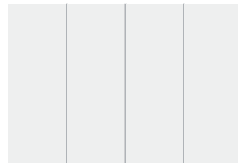

Style	422	440	470
Up-and-over door N 500			
Colour	Traffic white RAL 9016 7 preferred colours RAL to choose	Traffic white RAL 9016 7 preferred colours RAL to choose	
Max. width (mm)	5000	5000	
Max. height (mm)	2750	2750	
Non-protruding up-and-over door ET 500 / sliding door ST 500			
Colour	White aluminium RAL 9006 16 preferred colours RAL to choose	White aluminium RAL 9006 16 preferred colours RAL to choose	White aluminium RAL 9006 16 preferred colours RAL to choose
Max. width (mm)	6000 ¹⁾	6000 ¹⁾	6000
Max. height (mm)	3000	3000	3000

¹⁾ Door width with wicket door max. 5500 mm

²⁾ Door width with wicket door max. 5000 mm

³⁾ Style 432, 433 only available for ET 500 / ST 500

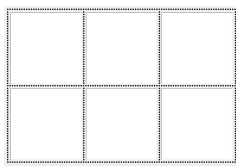

405

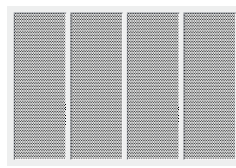

412 / 432 ³⁾

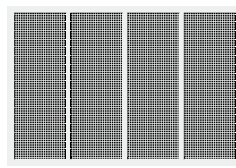

413 / 433 ³⁾

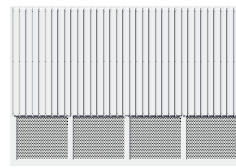

414



420

Terra brown RAL 8028
7 preferred colours
RAL to choose

5000
2750

Traffic white RAL 9016
7 preferred colours
RAL to choose

5000
2750

Traffic white RAL 9016
7 preferred colours
RAL to choose

5000
2750

Traffic white RAL 9016
7 preferred colours
RAL to choose

5000
2750

White aluminium RAL 9006
16 preferred colours
RAL to choose

6000 ²⁾
3000

White aluminium RAL 9006
16 preferred colours
RAL to choose

6000
3000

White aluminium RAL 9006
16 preferred colours
RAL to choose

6000
3000

White aluminium RAL 9006
16 preferred colours
RAL to choose

6000
3000

White aluminium RAL 9006
16 preferred colours
RAL to choose

6000 ¹⁾
3000

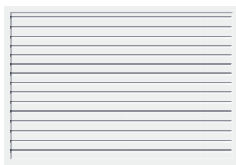

480

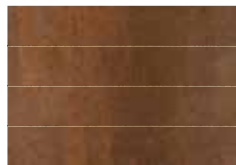

499

White aluminium RAL 9006
16 preferred colours
RAL to choose

5500 ²⁾
3000

Individual
(Corten steel shown)

4250
3000

Steel doors

Door leaf versions

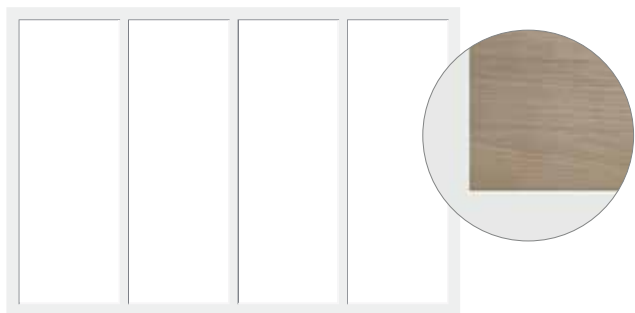

Style 400
Frames for on-site infill inside the frame
(detail figure shows infill example)

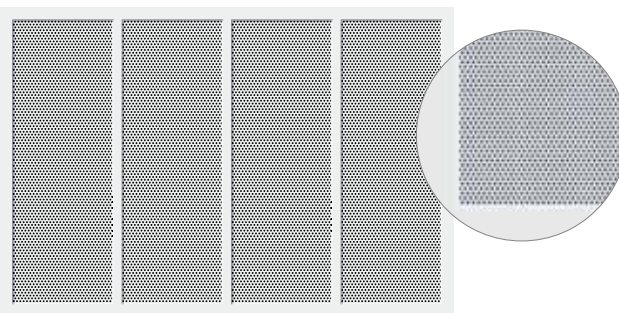

Styles 412 and 432
Internal, perforated sheet infill with round recesses,
ventilation cross section 46.1 %

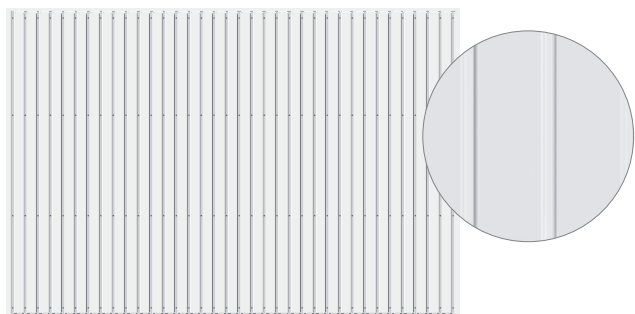

Style 402
Surface-mounted, ribbed sheet steel infill

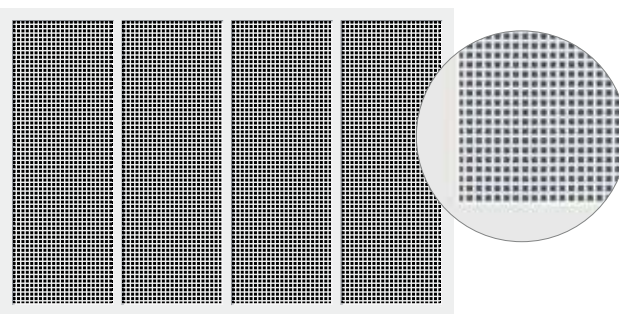

Styles 413 and 433
Internal, perforated sheet infill with square recesses,
ventilation cross section 44.4 %

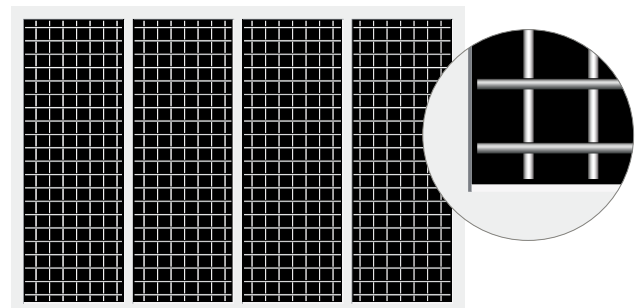

Style 403
Internal welded grille infill, ventilation cross section
85 %

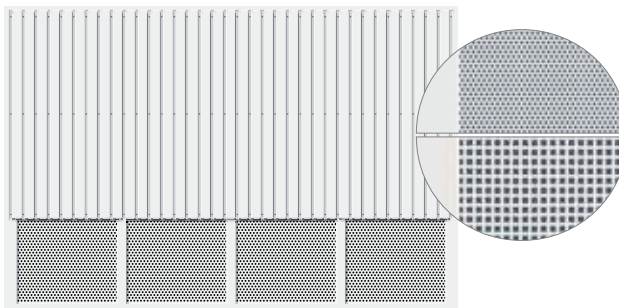

Style 414
Surface-mounted, ribbed sheet steel with perforated
sheet infill, round or square, ventilation cross section
46.1 % (round) or 44.4 % (square)

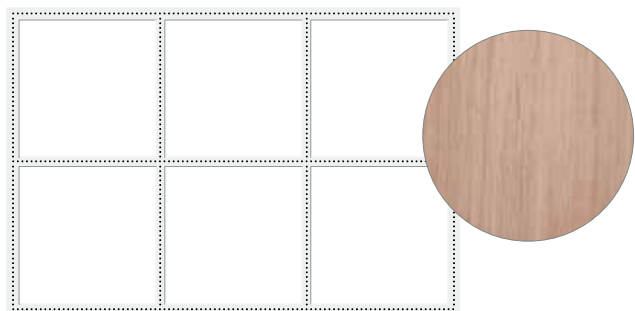

Style 405
Frames for surface-mounted, on-site cladding
(detail figure shows infill example)

Information on max. infill weight can be found in the technical manual.



Style 420
Internal, smooth aluminium sheet infill



Style 422
Surface-mounted, smooth aluminium sheet

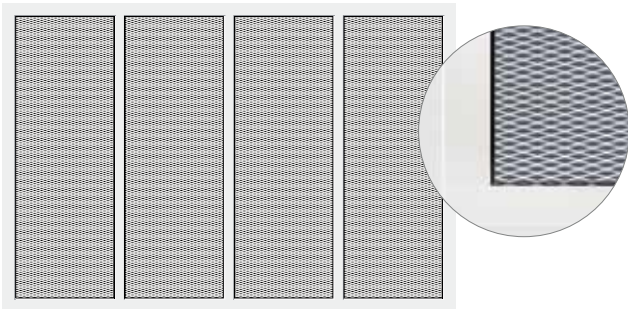

Style 440
Internal expanded mesh infill, ventilation cross section 50 %

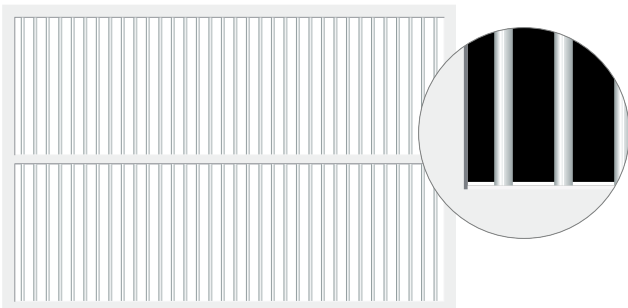

Style 470 ■ NEW
Infill with aluminium rods 20 x 20 x 2 mm, ventilation cross-section 80%

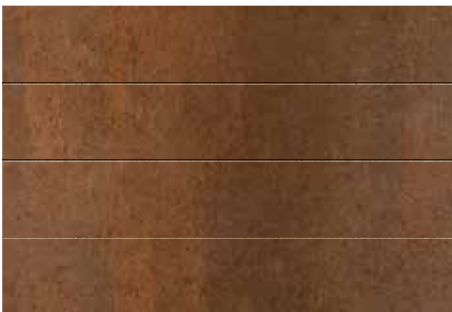

Style 499
Individual style, freely combined style variants or surface-mounted infill (Figure shows Corten steel base plate)

Style 480 with variants

The style 480 section infill is optionally available with integrated ventilation grilles. Additionally, the sections can also be individually combined with glazing or expanded mesh in aluminium frames.



Style 480
Section infill on the inside

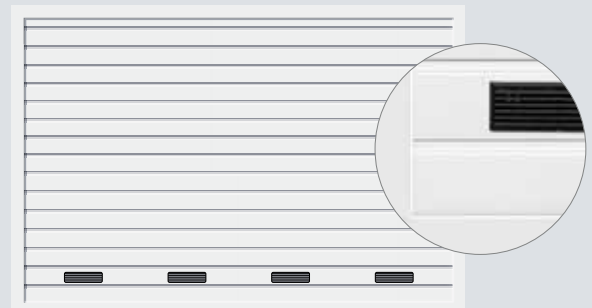

Style 480
Section infill on the inside with ventilation grille

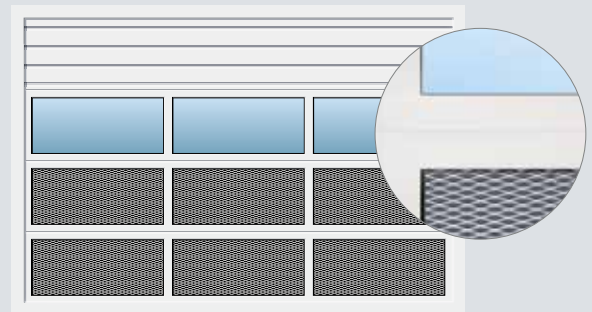

Style 480
Section infill on the inside with aluminium frame, glazing and expanded mesh infill.

Colours

For greater design freedom

Colours ET 500 / ST 500



Standard colour

1 RAL 9006 White aluminium

Preferred colours

2 RAL 9007 Grey aluminium

3 RAL 8028 Terra brown

4 RAL 8003 Clay brown

5 RAL 8001 Ochre brown

6 RAL 7040 Window grey

7 RAL 7035 Light grey

8 RAL 7030 Stone grey

9 RAL 7016 Anthracite grey

10 RAL 6009 Fir green

11 RAL 6005 Moss green

12 RAL 5014 Pigeon blue

13 RAL 5011 Steel blue

14 RAL 5003 Sapphire blue

15 RAL 3003 Ruby red

16 RAL 1015 Light ivory

Colours N 500

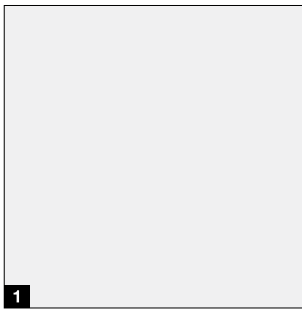

1

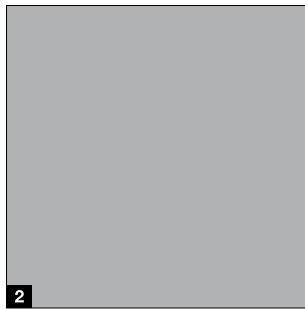

2



3

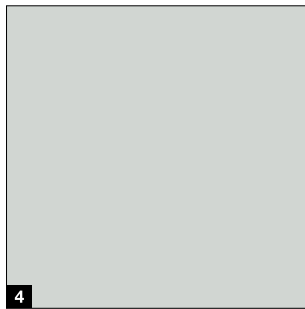

4

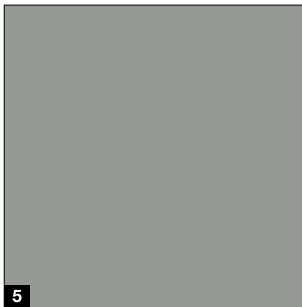

5



6



7

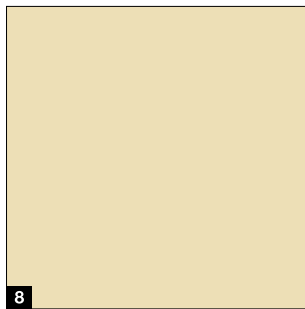

8

Standard colour

1 RAL 9016 Traffic white

Preferred colours

2 RAL 9006 White aluminium

3 RAL 8028 Terra brown

4 RAL 7040 Window grey

5 RAL 7035 Light grey

6 RAL 7016 Anthracite grey

7 RAL 6009 Fir green

8 RAL 1015 Light ivory

Infills for ET 500 / ST 500 style 499

NEW on request

- Sintered base plate made of granite, slate, quartz and special fibreglass reinforcements
- Plate thickness up to 5.5 mm
- High strength and weather resistance



1

1 Corten steel

2 Stone

3 Concrete



2

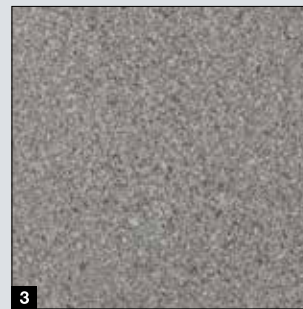

3

RAL to choose

All door types are optionally available in approx. 200 RAL colours* as well as special colours.

Please note:

All colours based on RAL. The colours and surface finishes shown are subject to the limitations of the printing process and cannot be regarded as binding. Please consult with your local Hörmann specialised dealer.

* RAL Classic colours, with the exception of pearl-effect, fluorescent and metallic colours

Up-and-over door N 500

Equipment





Well thought-out door construction

The sturdy and open construction ensures precise and safe opening and closing. Thanks to the mechanical anti-lift kit of the operator, the door is also locked securely.

Harmonious door appearance ¹

For a harmonious door appearance, the door leaf and subframe are flush-fitting and have the same colour. The door can be fitted flush with the facade, in the reveal or behind it.

Safe opening mechanism ²

Stable lever arms with ball-bearings and track rollers with ball-bearings allow the door to operate smoothly, safely and precisely. The specially dimensioned multiple spring assembly has two functions: it supports safe door opening and closing and at the same time prevents the door leaf from falling. The open design also minimises the risk of crushing.

Well-sealed ³

Double seals on the door's lower edge effectively prevent the ingress of leaves, hail and snow.

Convenience with operator

The N 500 up-and-over door can be equipped with SupraMatic E/P operators. If the door is being used as a collective garage door, the SupraMatic HT operator packages with internal or external control are required. These packages additionally include the photocell EL 301 as well as a spring assembly for a longer service life. No additional headroom is required for fitting the operator. Optionally, the door can be operated or additionally locked by hand using a handle ⁴.

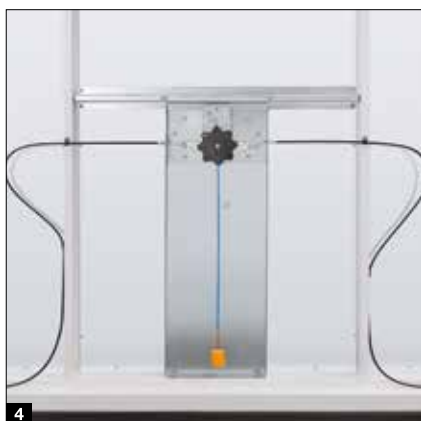

4



Optional handles for the N 500 can be found in the up-and-over garage doors brochure.

Non-protruding up-and-over door ET 500

Equipment





Lasting safe functionality even at high frequencies

The low-maintenance door construction with wear-free counter weight technology opens and closes smoothly, quietly and safely. It is designed for at least 250000 door cycles. Due to the limited frame depth, the space directly next to the door can also be used as a parking space.

Quiet door travel without swivelling out of the door leaf ¹

Precise roller guiding in the guide rail allows the door to run quietly and extremely precisely. If the door is fitted behind the opening or with a subframe, the ET 500 can be fitted directly adjacent to the street or pavement, since the door leaf does not swivel out.

Compact fitting dimensions ²

The ET 500 requires hardly any space: In combination with an operator, the required headroom is only 100 mm (SupraMatic HT) or 120 mm (ITO 500 FU). The same applies to sideroom: The space requirement here is 140 mm (ET 500 L) or 250 mm (ET 500 S). The small frame depth of max. 450 mm (ET 500 L) or max. 400 mm (ET 500 S) means that the space directly next to the door can also be used as a parking space. Thanks to the minimal distance back there is also more ceiling space.

Sturdy and safe construction ³

The entire door construction is extremely long-lasting and low-maintenance: the wear-free counter weight technology is designed for at least 250000 door cycles. Double cables also prevent the door leaf from falling.

Exemplary safety with integrated photocell ³

The open construction features the greatest operational safety in tough everyday operation: A safety clearance between the door leaf and building structure as well as on the bottom and side edges ensures a reliable trap guard. A special EPDM profile shape secures the closing edge. The integrated photocell is already pre-assembled in the frame and is easily installed on the operator.

Sliding door ST 500

Equipment

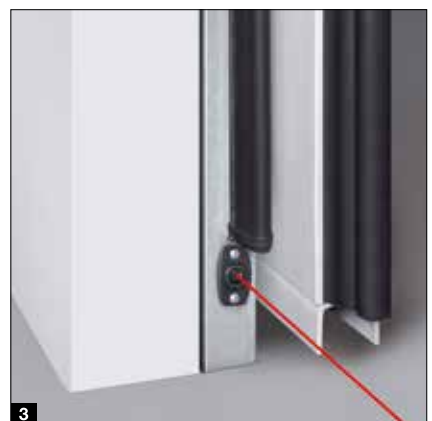



Low space requirements for optimised use of space

The collective garage sliding door ST 500 requires very little fitting depth. As a result, parking spaces can also be used directly next to the door. Thanks to the narrow door subframe, it can also be fitted with very low headroom.

Particularly space-saving 1

The small fitting depth of 450 mm incl. operator allows fitting where suspensions have been fitted to the garage ceiling. Thanks to the standard subframe, fitting is even possible if no lintel is available.

Sturdy and safe construction

The entire door construction is extremely long-lasting, maintenance-free and designed for at least 250000 door cycles.

Quiet and safe door travel 2

Twin rollers in the upper guide rail and guide rollers with ball-bearings at the floor offer smooth, quiet door travel and almost silent opening and closing. As a result, the door is securely guided over its entire travel range, even in the parking area.

Exemplary safety 3

Safety profiles at the inlet and the closing edge of the door as a standard feature and photocell pre-assembled in the door opening as standard offer full protection against injuries and material damage.

Side doors and wicket doors

Easy access to the garage

Side doors **1**

Equipment

- Single-leaf door set
- 80 mm frame construction, galvanized and with powder-coated primer in White aluminium, RAL 9006
- 60 mm frame profile made of galvanized square tubes, powder-coated in door leaf colour
- 3-way adjustable aluminium hinges **3**
- Lever handle set **6**
- Optional: Overhead door closer with slide rail, with / without hold-open device **7**
- Optional: Meeting style all-round on 3 sides, for side doors opening inwards (standard for styles 420, 422 and 480)

Wicket doors **2**

Door versions

- Non-protruding up-and-over door ET 500 and sliding door ST 500
- Styles 412, 413, 432, 433, 420, 422, 470, 480, 405, 400 and 499

Equipment

- 80 mm frame construction, galvanized and with powder-coated primer in White aluminium, RAL 9006
- ET 500: Lever handle set **6** and 3-way adjustable aluminium hinges **3**, optionally with concealed hinges **4**
- ST 500: Lever handle set (interior) **6** or pull handle (exterior) **5** and concealed hinges **4**
- Overhead door closer with slide rail, with / without hold-open device **7**

Fittings

- Mortice lock with profile cylinder
- Offset lever handle set with oval rose escutcheons, made of black plastic **8**
- On request also available as lever / knob handle sets
- Optionally available in natural finish cast aluminium **9**, polished stainless steel **10** or brushed stainless steel **11**



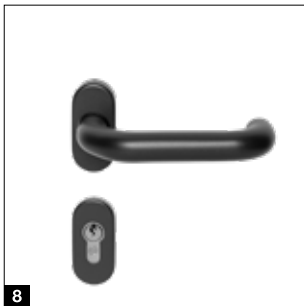

Multi-purpose door MZ Thermo65

Steel side doors with thermal break

- 65 mm thick door leaf with thermal break and PU rigid foam infill
- Aluminium block frame with thermal break and threshold with thermal break
- High thermal insulation with a U-value = 0.82 W/(m²·K)
- Optionally available in an RC 2 version as KSI Thermo46 with 46 mm thick door leaf



For further information, see the "Steel doors" brochure.

Operators

SupraMatic 4

Supra-fast door opening and smart additional functions

- 40% faster opening speed¹⁾ up to 20 cm/s
- Smart operation with the Hörmann BlueSecur app
- Convenient garage ventilation
- Additional opening height
- Up to 3 times (SupraMatic E) or 5 times¹⁾ (SupraMatic P) brighter LED lighting
- Easy-to-use programming thanks to 2 × 7-segment display
- High-quality stainless steel operator cover
- Networked with Smart Home systems via the standard HCP interface²⁾
- Low power consumption in standby below 1 watt



 **BiSecur**

As standard with two 4-button hand transmitters HSE 4 BS, textured surface black with chrome caps

Garage door operators	SupraMatic E	SupraMatic P	SupraMatic HT 3
Up-and-over door N 500	○	○	○
Non-protruding up-and-over door ET 500/ sliding door ST 500	-	-	●
Bluetooth receiver for Hörmann BlueSecur app	Integrated, can be switched on and off	Integrated, can be switched on and off	Optional (HET-BLE)
HCP bus connection	Integrated	Integrated	Integrated ²⁾
Cycles per day / hour	25 / 10	50 / 10	300 / 30
Pull and push force	650 N	750 N	1000 N
Peak force	800 N	1000 N	1200 N
Max. opening speed	20 cm/s	20 cm/s	22 cm/s
Lighting	20 LEDs	30 LED chase light	-
Max. door width	5500 mm	6000 mm	6000 mm
Max. door surface	13.75 m ²	15 m ²	18 m ²

● = Standard ○ = Optional - = Not possible

¹⁾ In comparison with the ProMatic series 3

²⁾ With operator SupraMatic HT 3 not compatible with KNX gateway

Powerful operator with soft start and soft stop

- **NEW.** Fast opening speed of up to 50 cm/s
- Soft start and soft stop for quiet and gentle door travel
- Optional 2nd opening height
- Maintenance release as standard
- Emergency release via Bowden cable on the slide carriage (optionally possible from the outside)
- Optionally secured release on inside / outside (ideal for use on facade doors)
- Settings on a separate control via a control panel
- Automatic timer ¹⁾
- Prepared for traffic control¹⁾
- Integrated timer function²⁾
- Adaptive door action check with intelligent speed control



Hörmann BlueControl app
For smart set-up and adjustment of operator control

Garage door operators

ITO 500 FU

Up-and-over door N 500	–
Non-protruding up-and-over door ET 500 / sliding door ST 500	○
Bluetooth receiver for Hörmann BlueControl app	Integrated
Bluetooth receiver for Hörmann BlueSecur app	Optional (HET-BLE)
HCP bus connection	Integrated
Cycles per day / hour	450 / 30
Pull and push force	1500 N
Peak force	2000 N
Max. opening speed	50 cm/s
Max. door width	6000 mm
Max. door surface	18 m ²

● = Standard ○ = Optional – = Not possible

¹⁾ Only in combination with an activating kit for warning lights and photocell / light grille

²⁾ With control 560



The control for the operator

Using the menu on the optimally matched control for the ITO 500 FU, you can quickly and easily set, for example, desired hold-open phases and visual indicators of warning lights.



Activating kits for warning lights

Warning lights secure and control the entrance and exit of the door system. Yellow warning lights alert when the door is moving, red / green activating kits for warning lights serve as a visual indicator for controlling the entrance and exit.

Accessories

Hand transmitter



HS 5 BS
4 button functions, plus query button, high-gloss surface black or white



HS 5 BS
4 button functions, plus query button, textured surface matt black



HS 4 BS
4 button functions, textured surface matt black



HS 1 BS
1 button function, textured surface matt black



HSE 1 BS
1 button function, including eyelet for key ring, textured surface matt black



HSE 4 BS
4 button functions, incl. eyelet for key ring, textured surface matt black with chrome or plastic caps



HSE 4 BS
4 button functions, incl. eyelet for key ring, high-gloss surface with chrome caps, colours (shown from left): Anthracite grey, Frozen Grey, Classic Grey, Carbon, Silver



RSC2
2 button functions, including eyelet for key ring, textured surface matt black, Rolling Code radio system (433 MHz)



HSD 2-C BS
High-gloss chrome, 2 button functions, can also be used as a key ring



HSZ 1 BS / HSZ 2 BS
1 or 2 button functions, for insertion in vehicle cigarette lighter



Hand transmitter station
In high-gloss surface black or white, textured surface matt black, for HS 5 BS, HS 4 BS, HS 1 BS



Hand transmitter holder
For wall fitting or fastening to the sun visor of a car, transparent, for HS 5 BS, HS 4 BS, HS 1 BS as well as HSE 1 BS and HSE 4 BS



The complete range of accessories can be found in the door operators and Smart Home systems brochure.



**Radio code switch
FCT 3 BS**
3 functions, with illuminated buttons, recessed or surface-mounted fitting possible, plastic housing in Light grey RAL 7040 (also available with 10 functions and hinged cover, painted in White aluminium RAL 9006)



**Radio code switch
FCT 10 BS**
10 functions, with illuminated buttons and hinged cover, recessed or surface-mounted fitting possible, plastic housing in White aluminium RAL 9006



**Radio finger-scan
FFL 25 BS**
2 functions and up to 25 fingerprints, with hinged cover, recessed and surface-mounted fitting possible, plastic housing painted in White aluminium RAL 9006

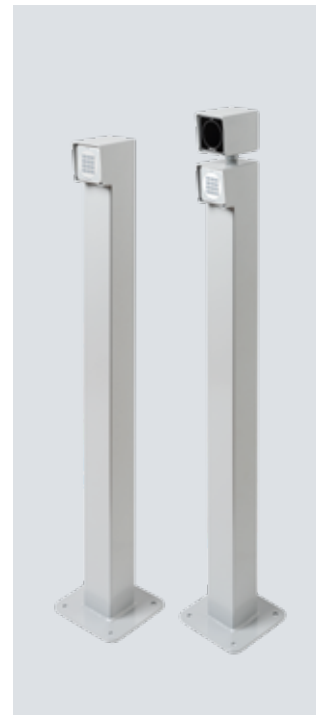

Key switch posts
With a screw base for fitting to the floor, surface finish in White aluminium RAL 9006, 90 x 90 mm tube, also available as a set-in-concrete version

Key switch post STN 1
To hold 1 command unit on the surface, height 1050 mm

Key switch post STN 1-1
To hold 2 command units or 1 command unit and 1 warning light, height 1200 mm

For command units:
CTR 1b-1, CTR 3b-1, CTV 3-1, CTP 3-1, TTR 1000-1, FL 150, STUP 50, LED double warning lights red / green

Switch



**Transponder key switch
TTR 1000-1**
1 function, 1000 teachable keys, scope of delivery: 1 key and 1 card (more on request), zinc die-cast housing in White aluminium RAL 9006



**Code switches
CTP 3-1**
3 functions, with illuminated lettering and touch-sensitive black surface, zinc die-cast housing in White aluminium RAL 9006



**Code switches
CTR 1b-1 / 3b-1**
1 or 3 functions, plastic housing in Light grey RAL 7040



**Code switch
CTV 3-1**
3 functions, particularly robust with metal keypad, zinc die-cast housing in White aluminium RAL 9006 with stainless steel panel



**Finger-scan
FL 150**
2 functions, control via fingerprint, up to 150 savable fingerprints, zinc die-cast housing in White aluminium RAL 9006 with stainless steel panel



Key switch
1 STUP 50
2 STAP 50
Recessed version and surface-mounted version, incl. 3 keys, zinc die-cast housing in White aluminium RAL 9006 with stainless steel panel

Dimensions and technical manual

Size ranges

ET 500 L – lightweight version and ST 500

ET 500 S – heavy version and ST 500

N500

Styles 412, 413

Doors with perforated steel sheet infill

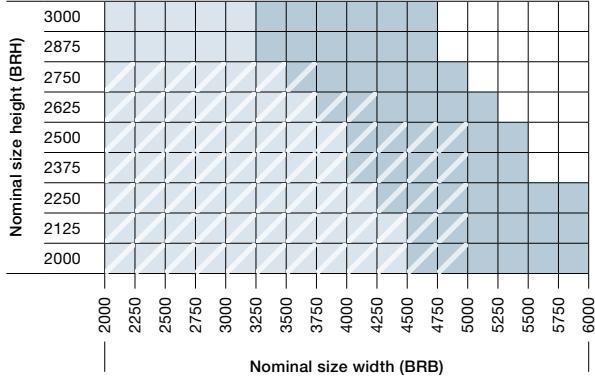

Styles 432, 433

Doors with aluminium perforated sheet infill

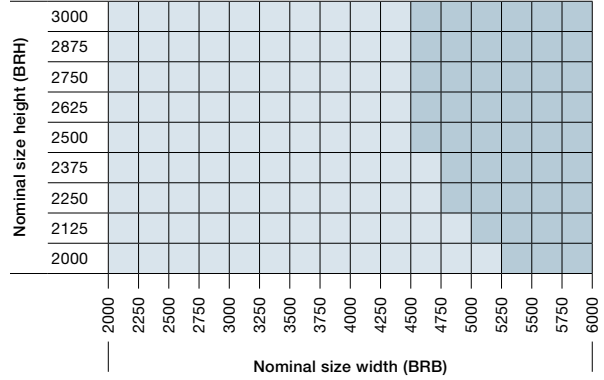

Style 420

Doors with aluminium sheet infill inside the frame

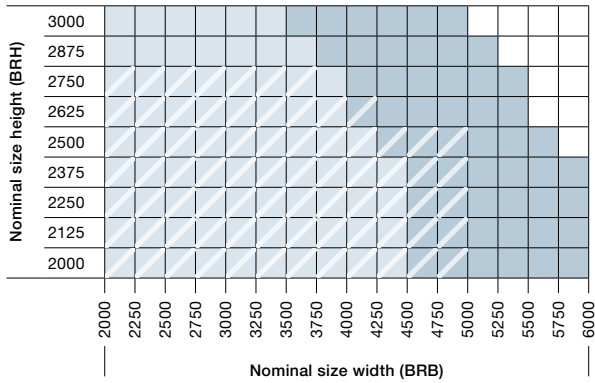

Style 480

Doors with section infill

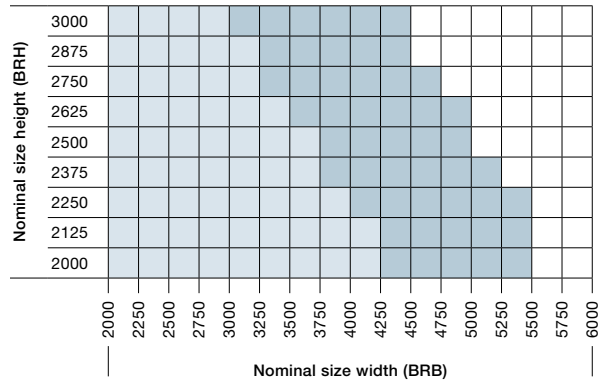

Style 402

Doors with surface-mounted ribbed sheet infill

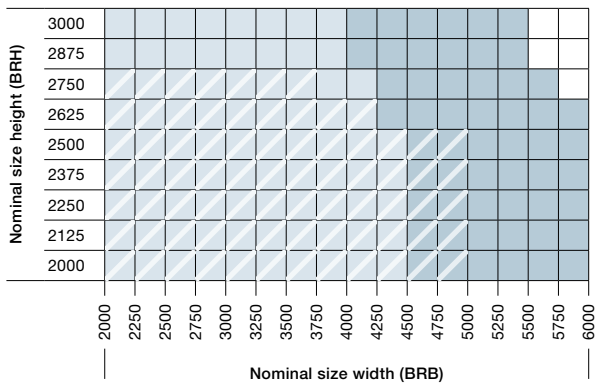

Style 414

Doors with surface-mounted ribbed sheet infill

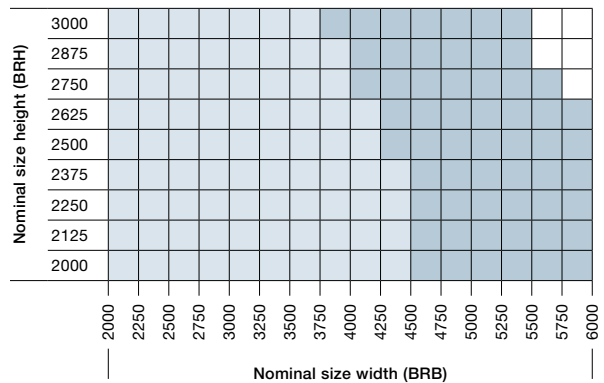

Dimensions in mm

Style 422

Doors with surface-mounted aluminium sheet infill

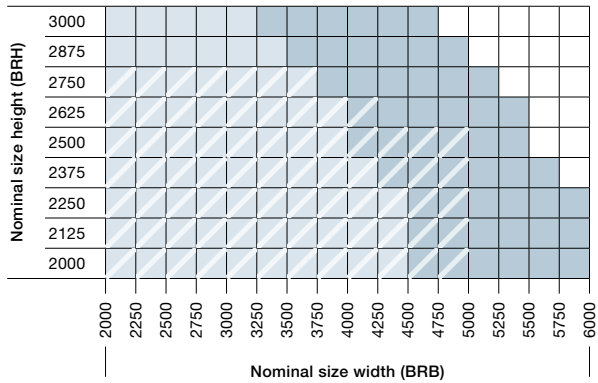

Style 400

Doors for on-site infill inside the frame

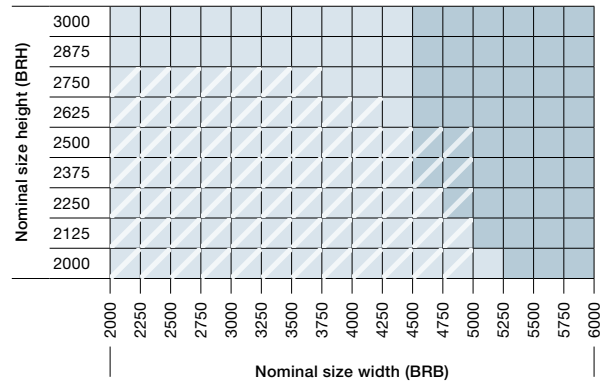

Style 405

Doors for on-site surface-mounted infill

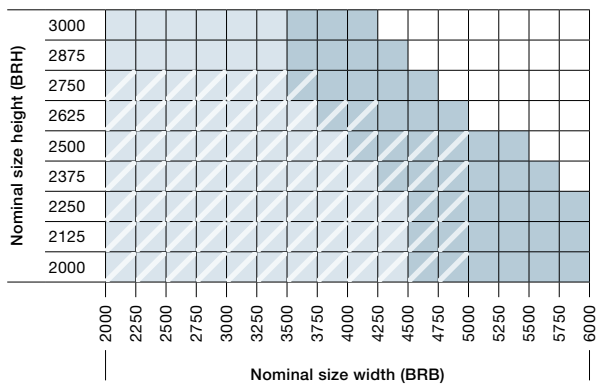

Style 403 (only N 500)

Doors with welded grille infill inside the frame

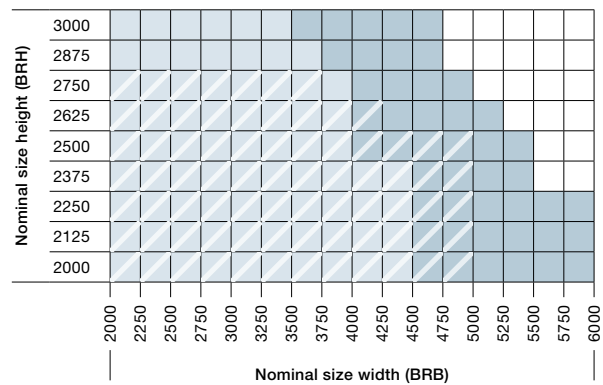

Style 440

Doors with expanded mesh infill inside the frame

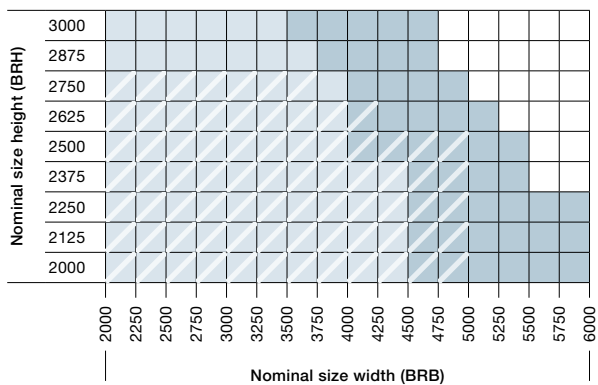

Style 470

Infill with aluminium rods 20 x 20 x 2 mm

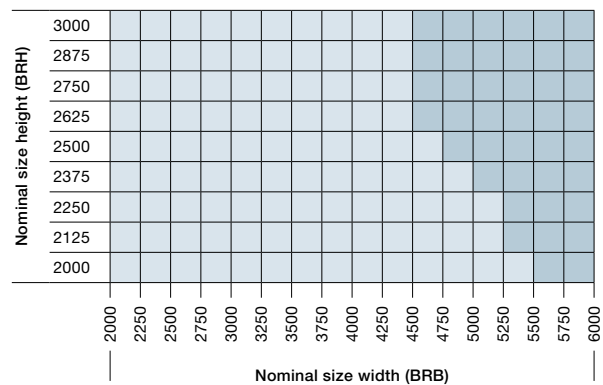

Style 499

Doors with combined infill

Up to 140 kg (ET 500 L)
Up to 200 kg (ET 500 S)

Dimensions in mm

Note

For the maximum infill weight please see the technical manual.

Dimensions and technical manual

ET 500, ST 500, N 500

ET 500 fitting behind the opening

Vertical view

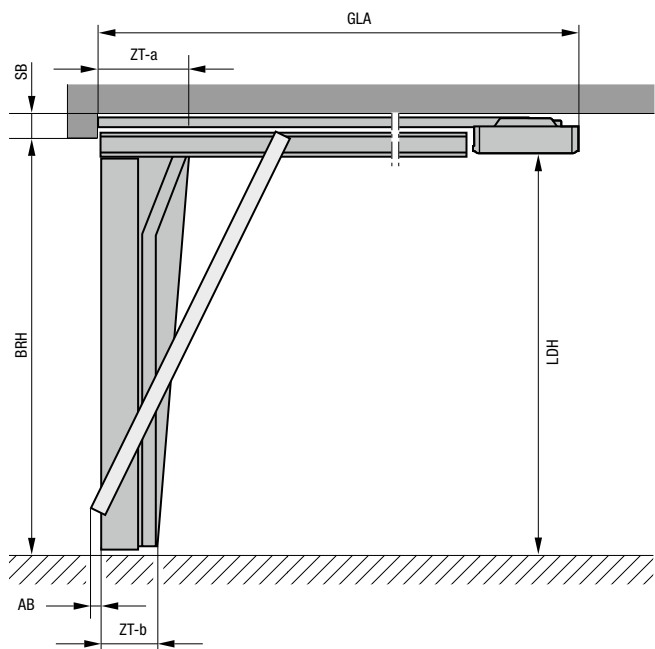

Horizontal view

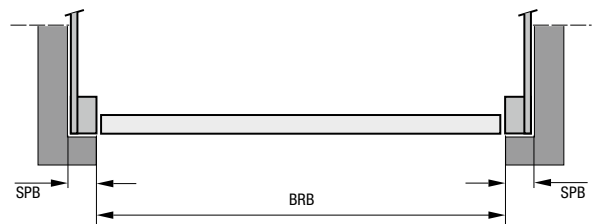

ST 500 fitting behind the opening

Vertical view

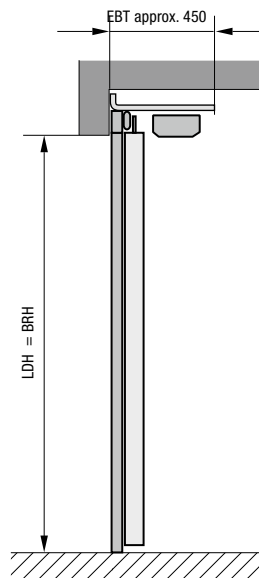

Horizontal view

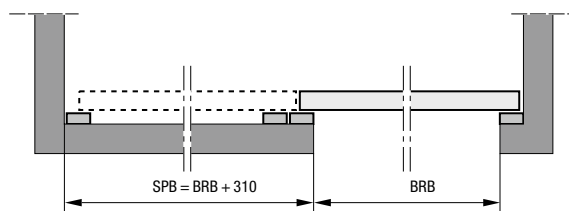

Note

For further information, please see the technical manual or contact your Hörmann partner.

Dimensions in mm

N 500 fitting behind the opening

Vertical view

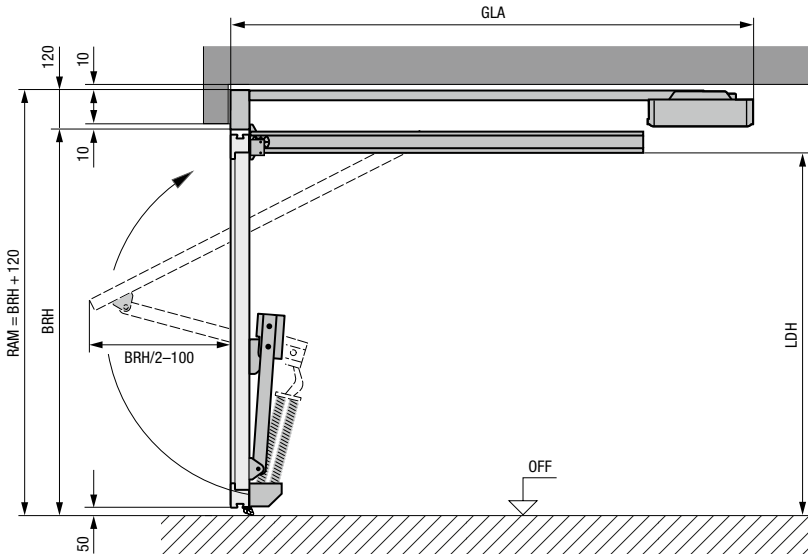

Horizontal view

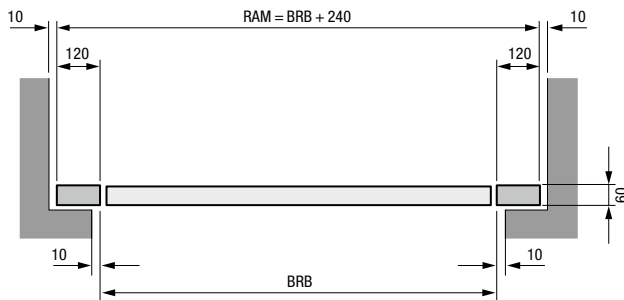

Dimensions in mm

Explanations

BRB	Nominal size width = ordering size
BRH	Nominal size height = ordering size
RAM	Overall frame dimension
LB	Clear opening height
LH	Clear opening width
LDB	Clear passage width
LDH	Clear passage height
SB	Required headroom
SPB	Side space requirement
ZT	Frame depth
AB	Swivelling range
OFF	Finished floor level

ET 500

Overall length with operator GLA

SupraMatic HT:	
BRH 2000 – 2250	3200
BRH 2255 – 2500	3450
BRH 2505 – 3000	4125
ITO 400 FU:	
BRH 2000 – 2700	3840
BRH 2705 – 3000	4840

Required headroom SB*

SupraMatic HT / ITO 400 FU	
Fitting behind the opening	100 / 120
With wicket door	100 / 120
With surface-mounted infill	y + 100 / y + 120
Fitting in the opening	120 / 140
With wicket door	120 / 140
With surface-mounted infill	y + 120 / y + 140
y = Thickness of surface-mounted infill	

Clear opening height LH

BRH = LH	2000 – 3000
----------	-------------

Clear passage height LDH

BRB < 4500	= BRH – 20
BRB ≥ 4500	= BRH – 60
With wicket door	= BRH – 70

Side space requirement SPB*

ET 500 L	At least 140
ET 500 S	At least 250

Clear opening width LB

BRB = LB	2250 – 6000
----------	-------------

Swivelling range AB with flush-fitting installation

ET 500 L	25
ET 500 S	30

Frame depth ZT-a / ZT-b

ET 500 L	450 / 295
ET 500 S	400 / 245

ST 500

Nominal size height BRH = clear opening height LH

BRH	2000 – 3000
-----	-------------

Nominal size width BRB = clear opening width LB

BRB	2250 – 6000
-----	-------------

Clear passage width LDB

(depending on the fitting situation)	
LDB	= BRB – 60

N500

Overall length with operator GLA

SupraMatic HT:	
BRH < 2500	3200
BRH < 2750	3450

Clear passage height LDH

BRB < 4000	= BRH – 130
BRB ≥ 4005	= BRH – 170

Clear passage height LDB

LDB	= BRB – 100
-----	-------------

Dimensions and technical manual

Wicket and side doors

ET 500 with wicket door

Vertical view

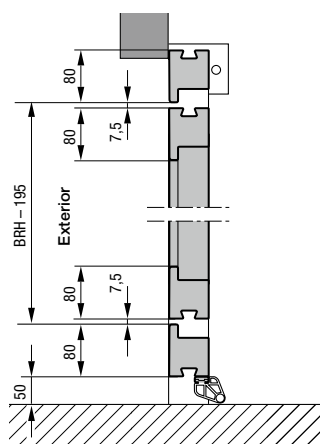

ST 500 with wicket door

Vertical view

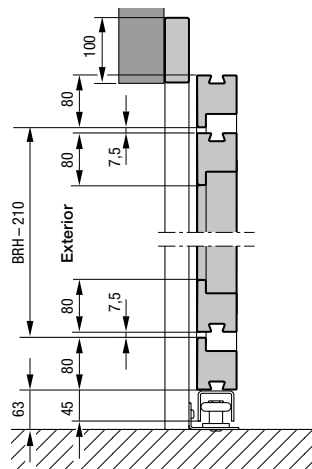

Horizontal view

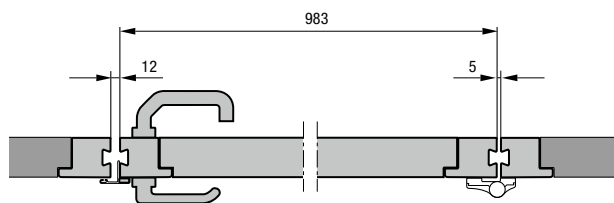

Horizontal view

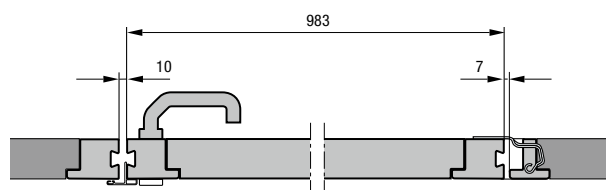

Note

For further information, please see the technical manual or contact your Hörmann partner.

Dimensions in mm

Side door fitting in the opening

Vertical view

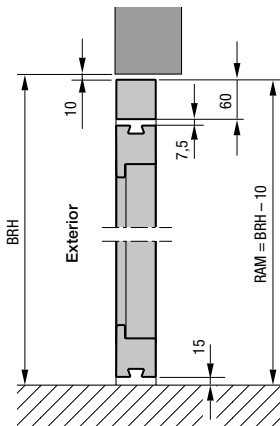

Side door fitting behind the opening

Vertical view

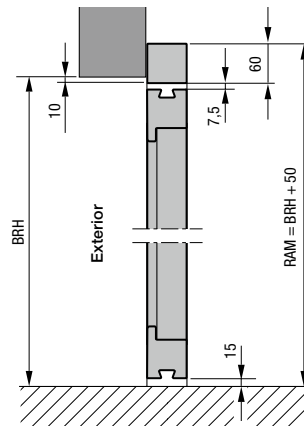

Horizontal view

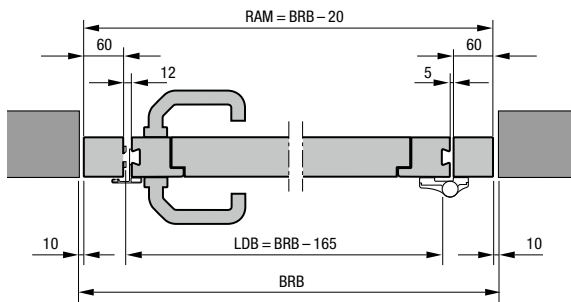

Horizontal view

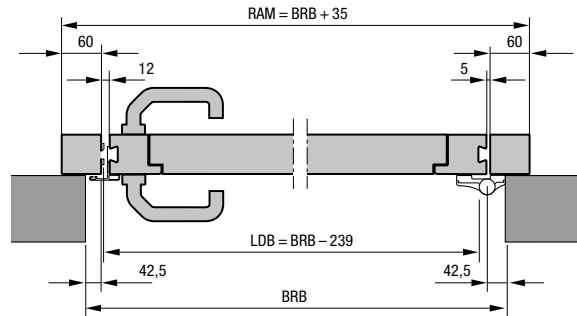

Clear passage width at an opening angle of 90°

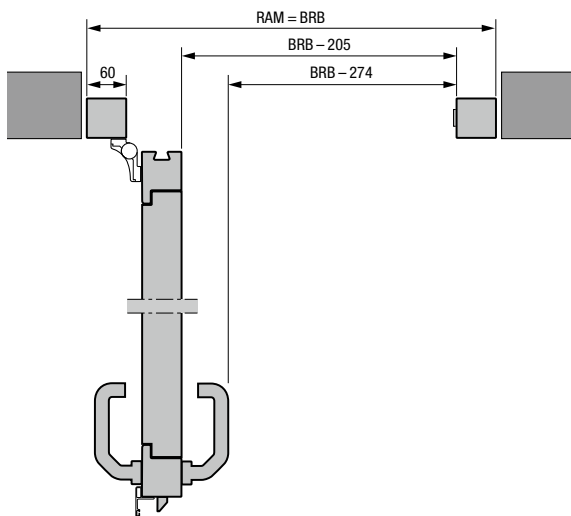

Dimensions in mm

Explanations

- BRB** Nominal size width
- BRH** Nominal size height
- RAM** Overall frame dimension = ordering size
- LDB** Clear passage width
- LDH** Clear passage height

Clear passage height LDH
Max. 2940 mm

Clear passage width LDB
Max. 1363 mm

Everything from a single source for residential and commercial construction

Our large product range offers the right solution for any requirement. All products are optimally adjusted to work together, ensuring high functional safety. This makes us a strong, future-oriented partner for residential and commercial construction projects.

INDUSTRIAL DOORS. LOADING TECHNOLOGY. SLIDING DOORS. CONSTRUCTION PROJECT DOORS. PERIMETER PROTECTION SYSTEMS



Some of the doors shown are equipped with special equipment and do not always correspond to the standard versions. The surface finishes and colours shown are subject to the limitations of the printing process and cannot be regarded as binding. All rights reserved. No part may be reproduced without our prior permission. Subject to changes.